

- Improved soft closing system guarantees smooth running
- Dynamic load capacity: 40 and 65 Kg
- Finish: White and Gray
- 68 mm casing height
- Wooden backboard thickness: 16 mm
- Drawer Length for 40 Kg: 270/300/350/400/450/500/550/600/650 mm
- Drawer Length for 65 kg: 450/500/550/600/650 mm
- Smart-Click: Tool free assembly and removal of front panel
- Smart-Fit: Simple and tool free assembly, as well as removal of drawer
- The improved stability guarantees a long product durability

Load Capacity	1	Smart Box
40 kg		Basic package
NOMINAL SIZE	CODE	PACKAGING
270 mm	12714721*	4 Set/Box
300 mm	12714722*	4 Set/Box
350 mm	12714723*	4 Set/Box
400 mm	12714724*	4 Set/Box
450 mm	12714725*	4 Set/Box
500 mm	12714726*	4 Set/Box
550 mm	12714727*	4 Set/Box
600 mm	12714728*	4 Set/Box
650 mm	12714729*	4 Set/Box

4	Front Panel	
	(LENGTH 1069 mm)	
COLOR	CODE	PACKAGING
White	12791711069	10 Pcs
Gray	12791731069	10 Pcs

5	Front Connectors	
	Without gallery railing ***	
COLOR	CODE	PACKAGING
White	12792311	10 Set
Gray	12792313	10 Set

\*\*\* Front panel holder included

Load Capacity	1	Smart Box
65 kg		Basic package
NOMINAL SIZE	CODE	PACKAGING
450 mm	12714925*	4 Set/Box
500 mm	12714926*	4 Set/Box
550 mm	12714927*	4 Set/Box
600 mm	12714928*	4 Set/Box
650 mm	12714929*	4 Set/Box

**A Metal Back Panel**

For order requirements and color options please refer to the **"Metal Back Panel Application"** section on (Page 245)

Basic package  
-Smart Box Slide Right-Left  
-Smart Box Side Right-Left  
-Back Panel Holder without Gallery Railing Right-Left  
-Front Connection Panel 2 Pieces  
-Decorative Covers 2 Pieces

1= White      3= Gray  
Colors can be chosen by adding the number of the color you desire instead of the (\*) sign. Example: For 40 kg, 500 mm White drawer (16 mm) =127139261

### Slide Mounting Dimensions

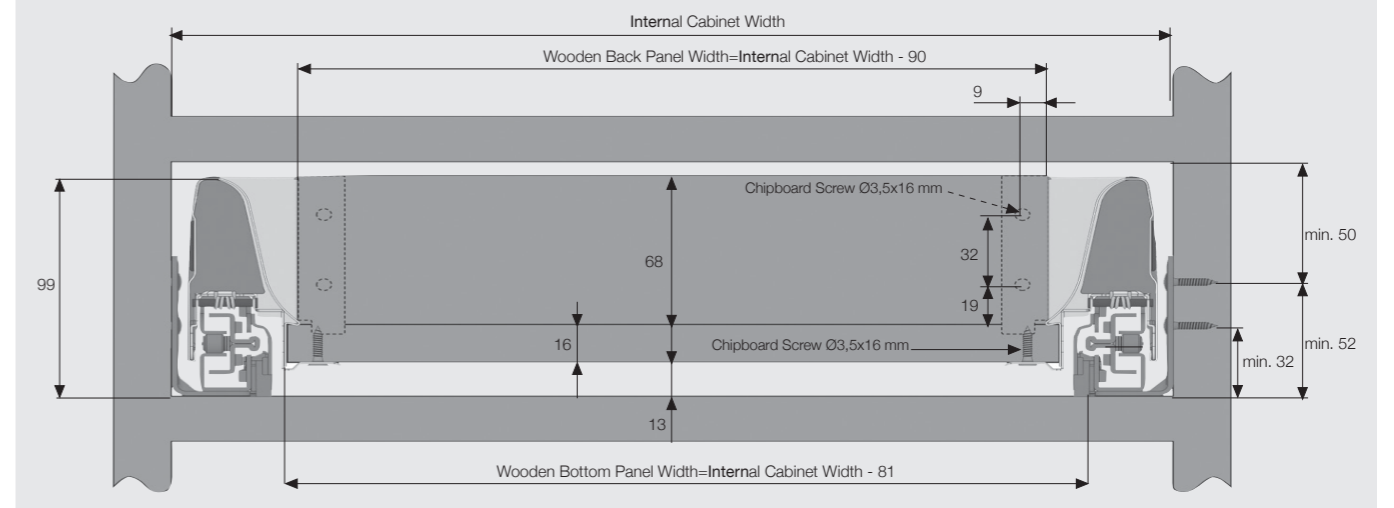

### Wooden Back Panel Application

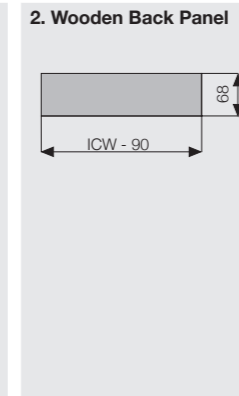
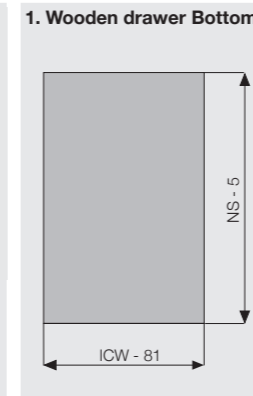
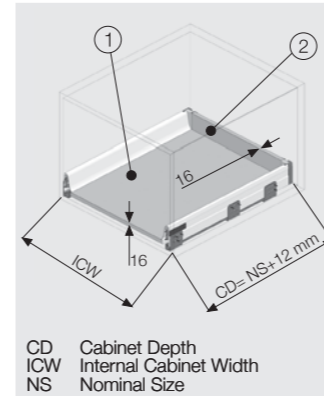

### Slide Screw Location

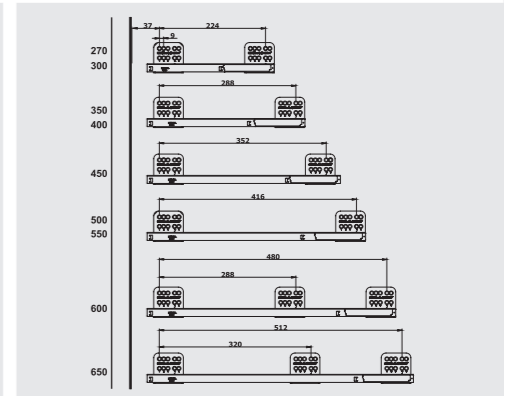

### Metal Back Panel Application

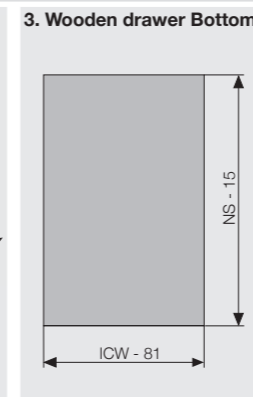
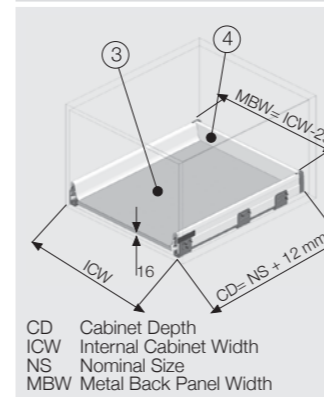

**4. Metal Back Panel without Gallery Railing**

Order Requirements: 1279031\*MBW  
To obtain your desired color please add one of the below-mentioned figures to the end of the seven-digit code.  
1= White    3= Gray  
Calculation for 18 mm thick side panels  
Example for cabinet width of 600 mm  
Internal Cabinet Width= 564 mm  
MBW= 564 mm - 29 mm= 535 mm  
Order: 12790311535

Color MBW

\*Special order of metal back panels can be made for drawers with wooden side panel thickness other than 18 mm

### Metal Back Panel without Gallery Railing

NOMINAL SIZE	White	GRAY	PACKAGING
300 mm	12790311235	12790313235	25 Pcs
450 mm	12790311385	12790313385	25 Pcs
500 mm	12790311435	12790313435	25 Pcs
600 mm	12790311535	12790313535	10 Pcs
800 mm	12790311735	12790313735	10 Pcs
900 mm	12790311835	12790313835	10 Pcs
1200 mm	127903111135	127903131135	10 Pcs

Calculation Method for Front Panel Dimensions: Cut Measurement = Internal Cabinet Width - 99

### Recommended Screws

Ø3,5x16 mm Chipboard Screw

Ø6,1x11,5 mm Euro Screw

\*All dimensions in the graphs above are measured in mm.