

hinge systems

Plus Soft Close Mechanism



- Applicable to hinges excepting cranking 0mm, 9mm and 18mm
- Applicable to hole Ø10mm.



Plus Soft Close Mechanism Hinge Side

Colour	Packing	Code
Grey	Each	10299909

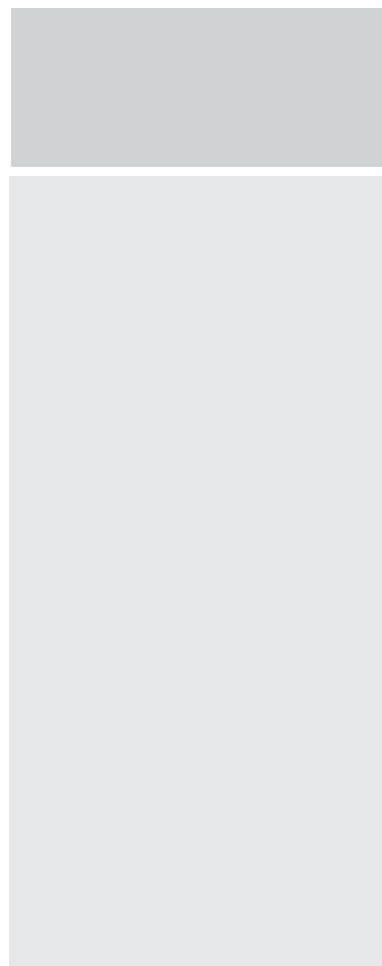
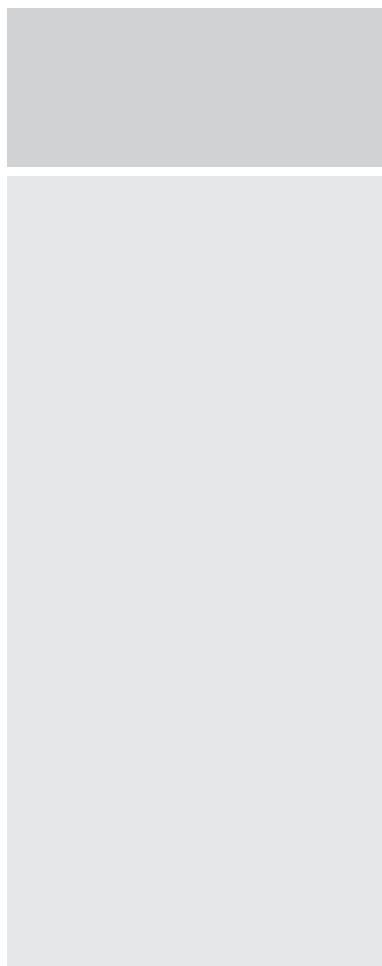
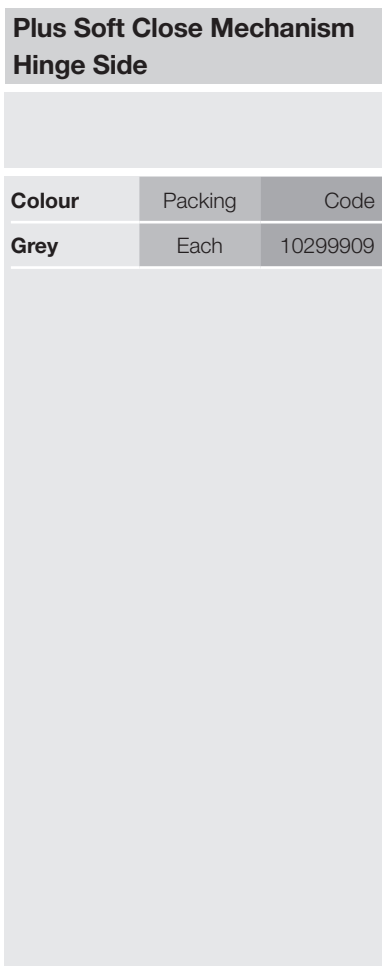

Page Directions

For Adapter Applications

Pg. F26, F27 and F28

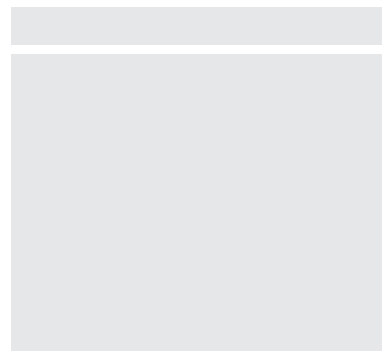

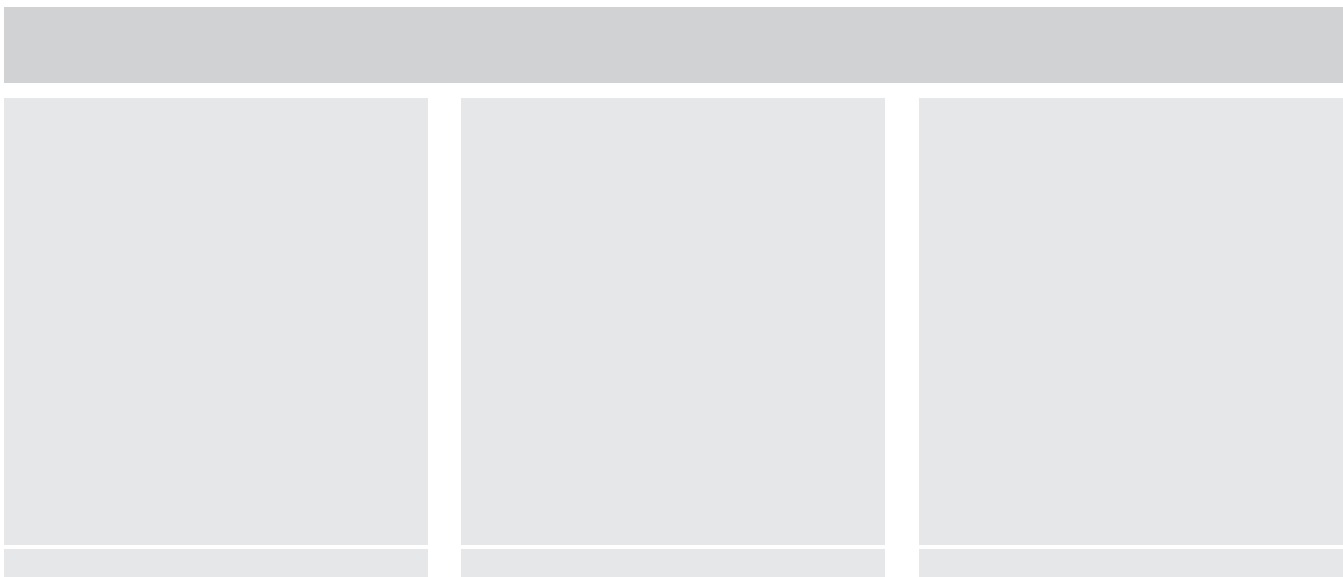

Dimensions (Hinge Side)

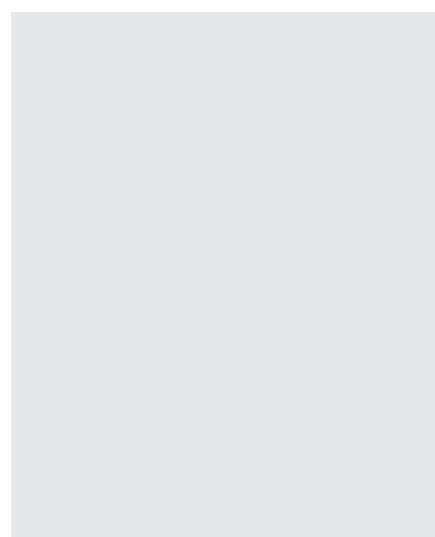
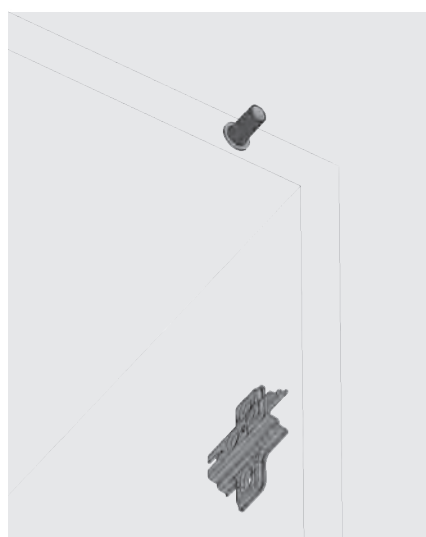
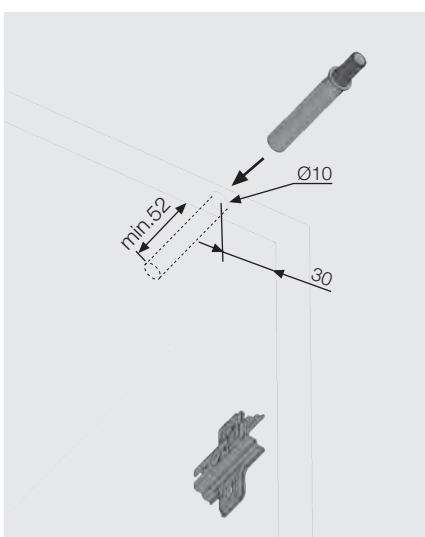

Hinge Side

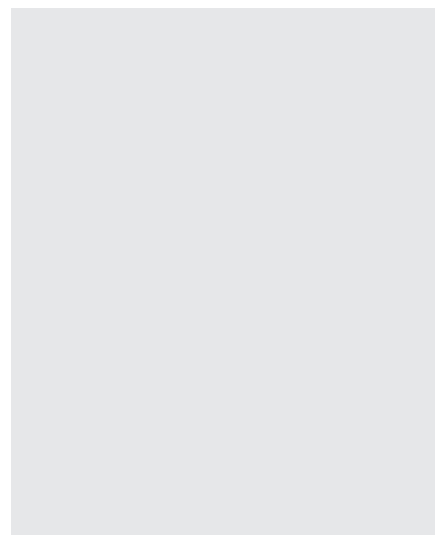
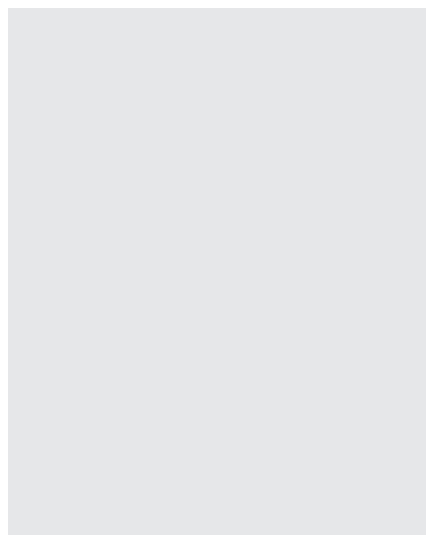

* Attention; Rubber on Plus Soft Close mechanism for "hinge side" must be dark colour